

➤BAD曲线图

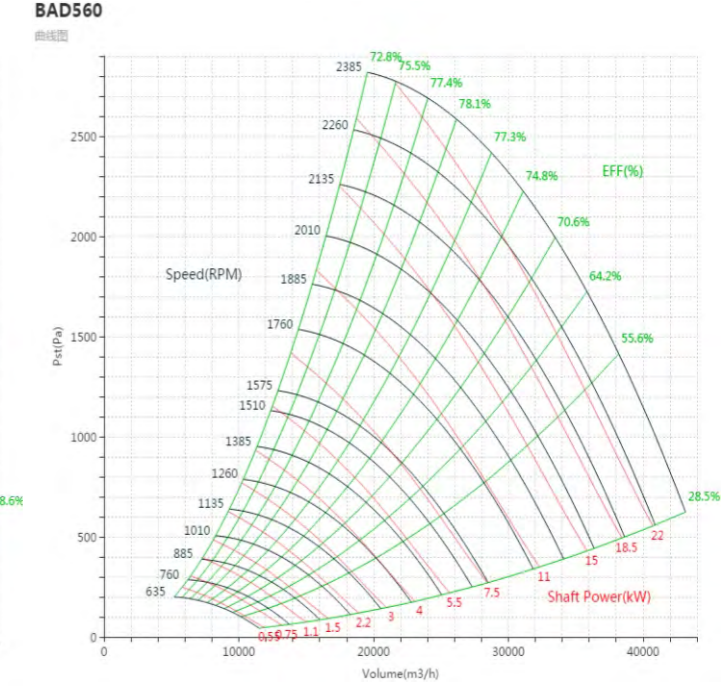
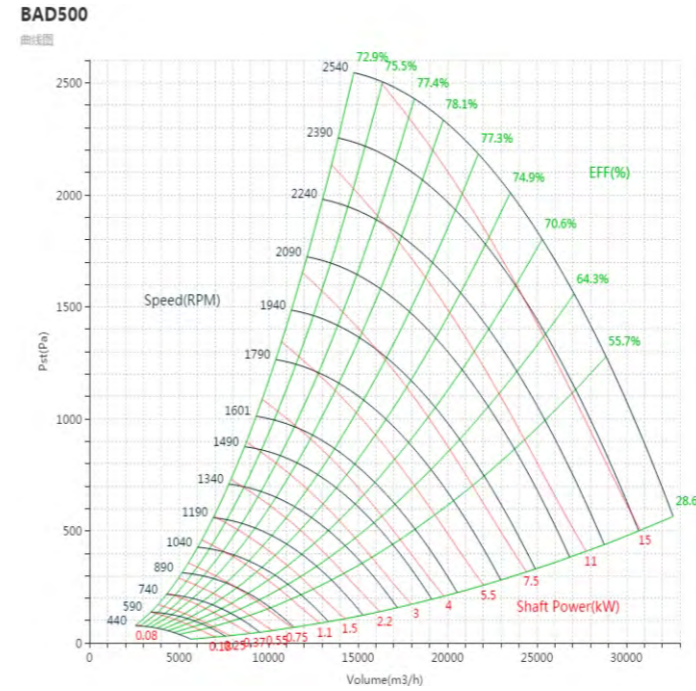
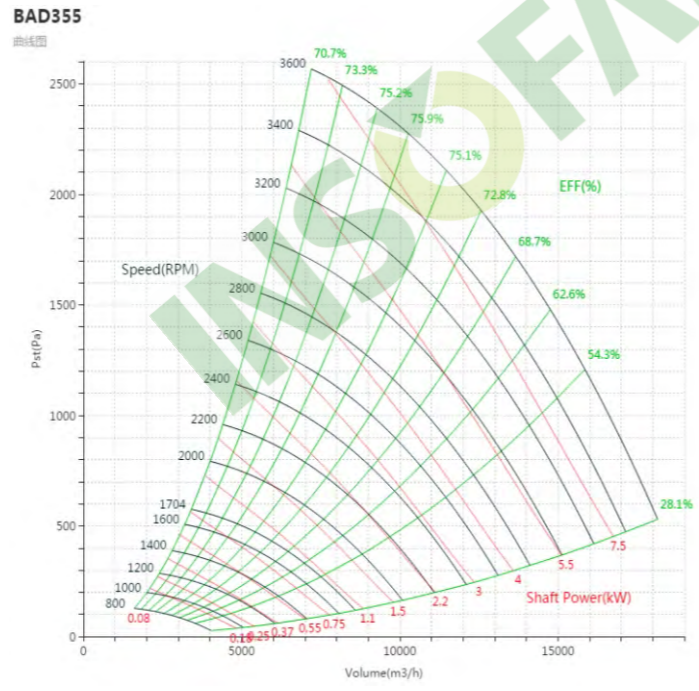
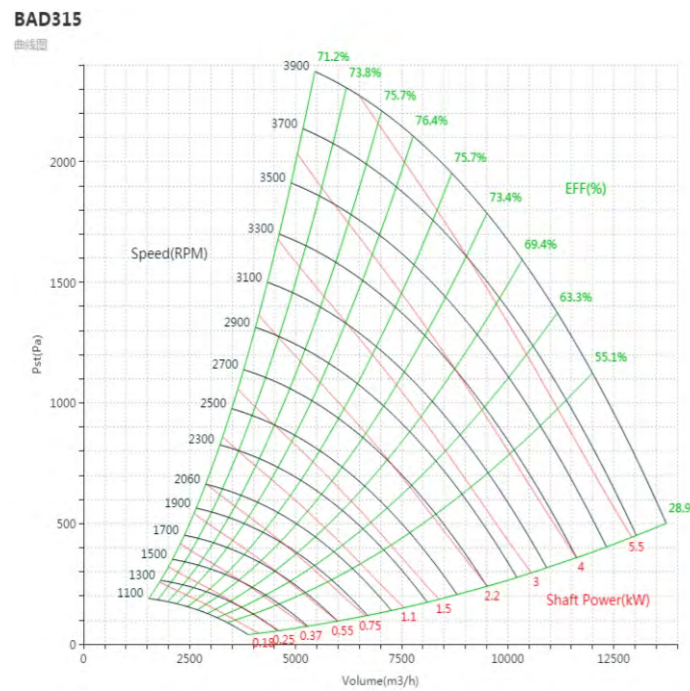
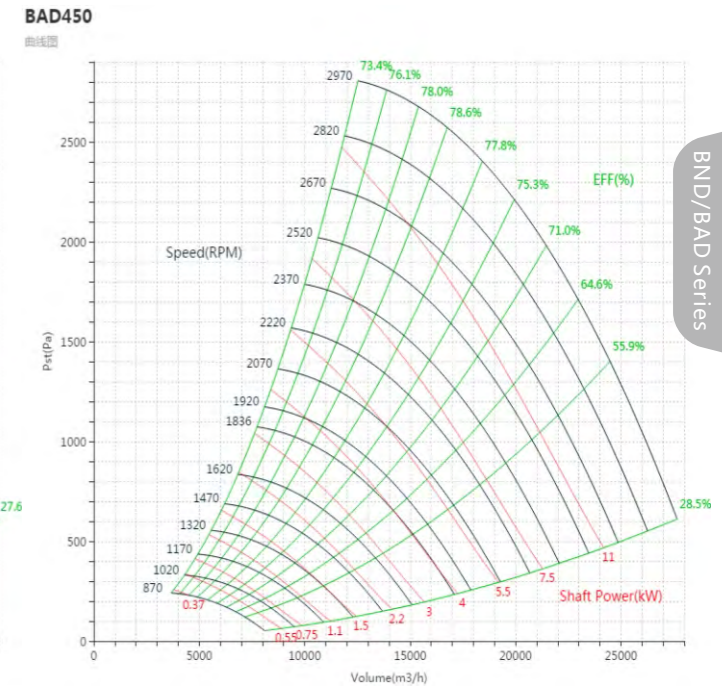
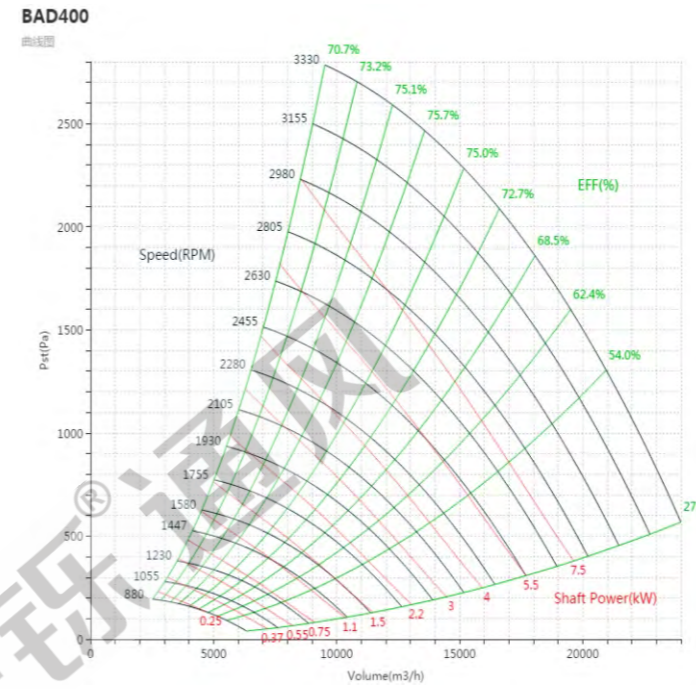
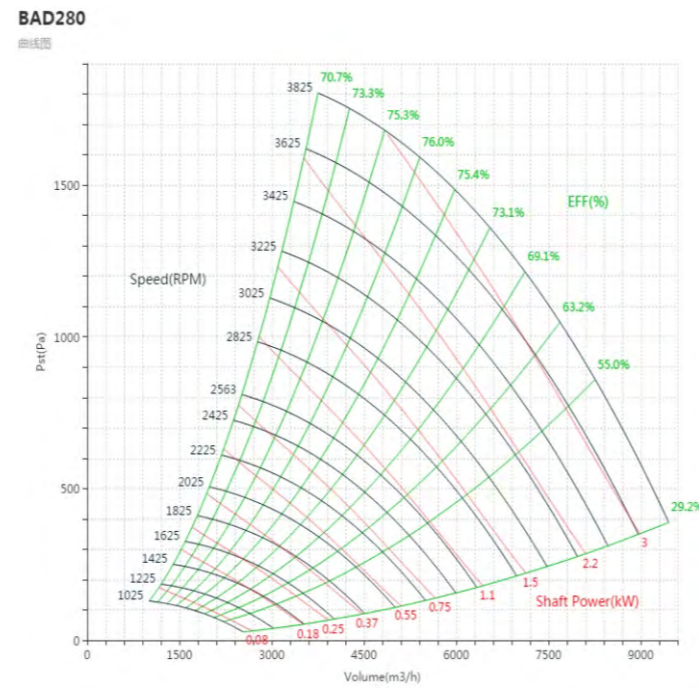
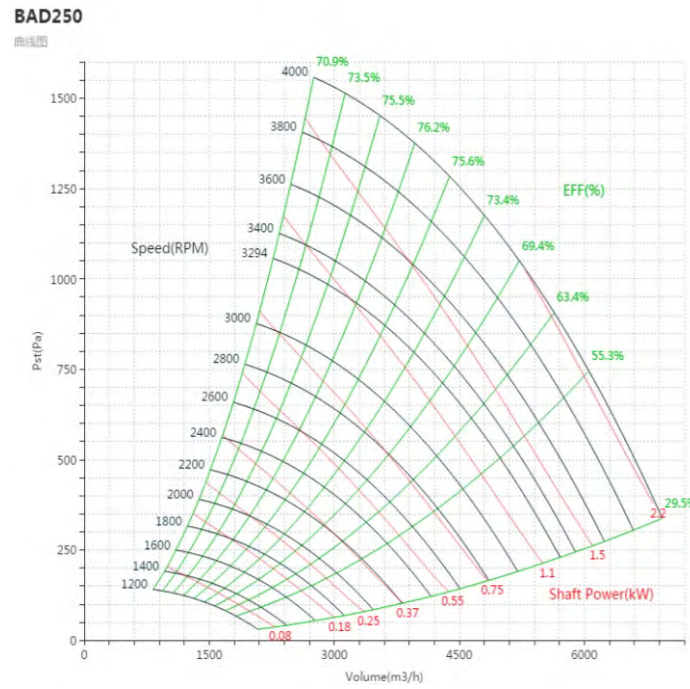

BND/BAD Series

BND/BAD Series

BND/BAD Series

BND/BAD Series

BAD630

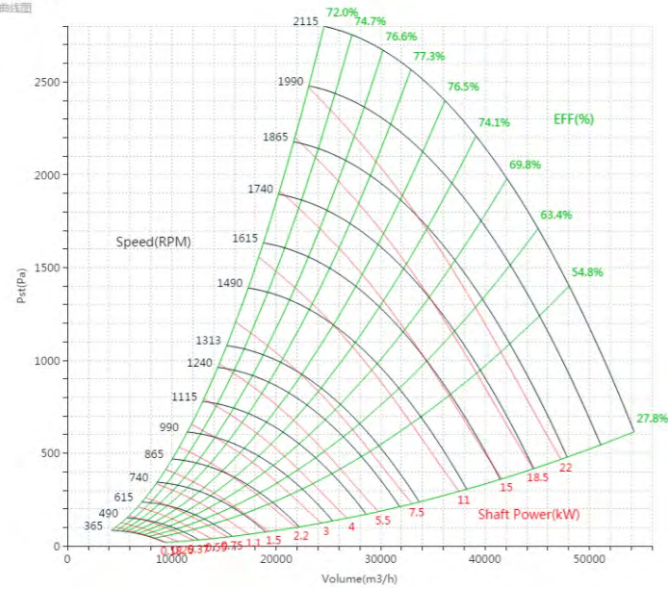

BAD710

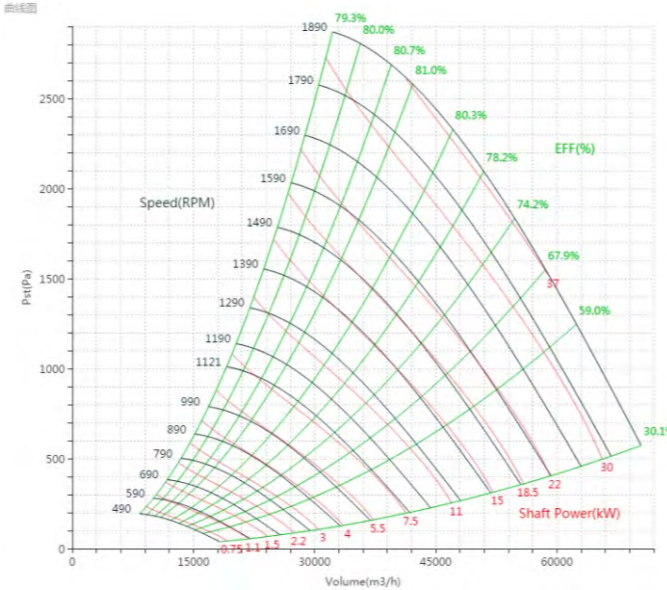

BAD1000

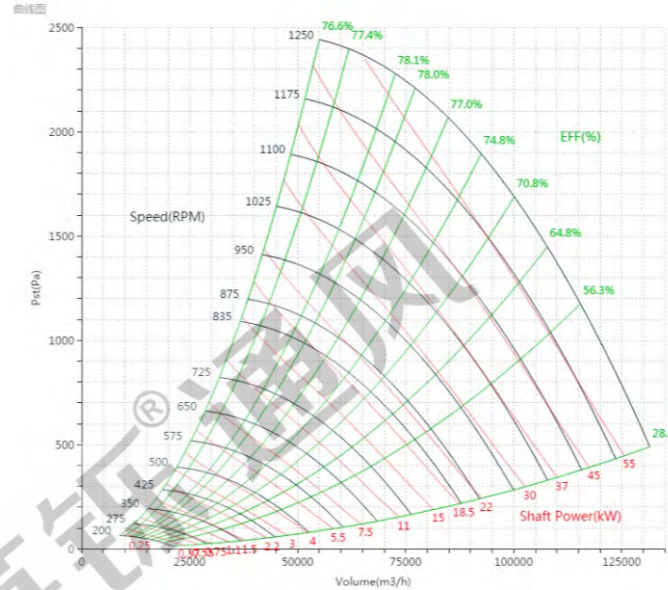

BAD1120

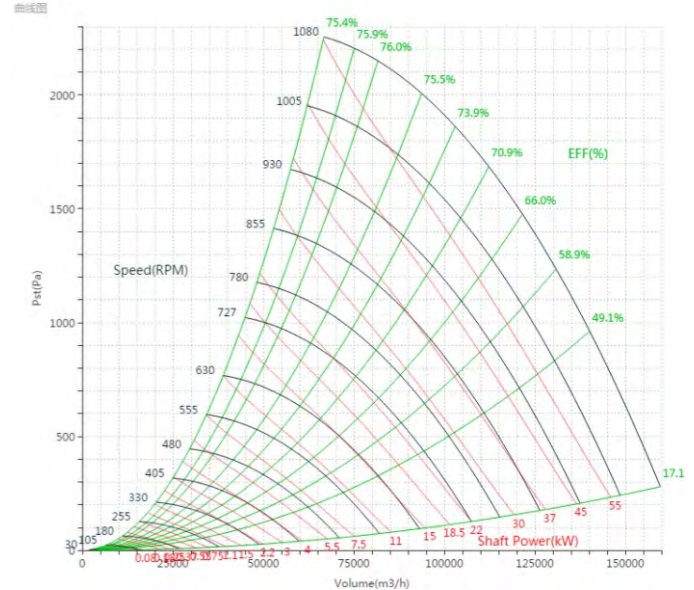

BAD800

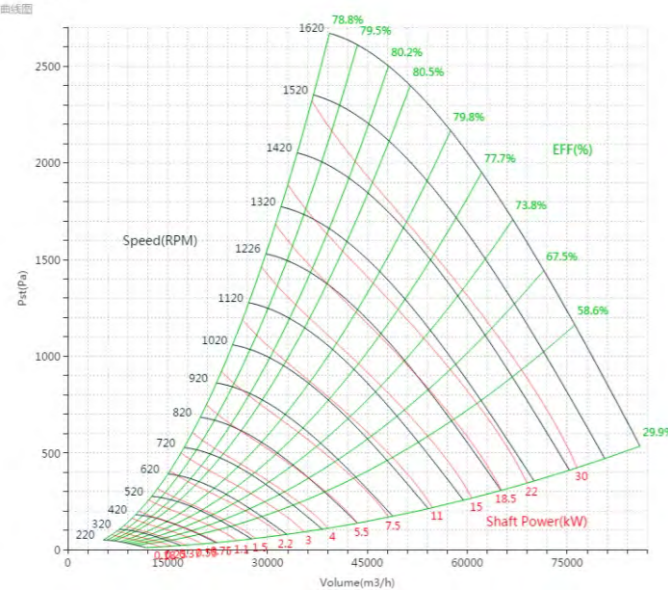

BAD900

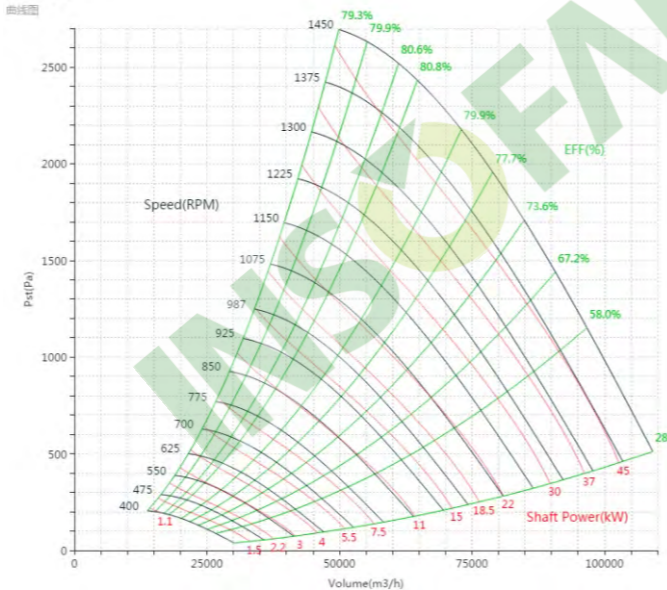

BAD1250

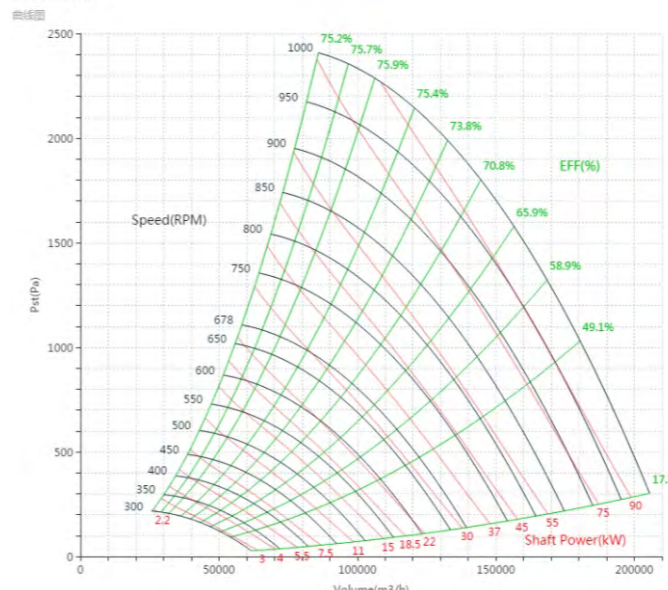

BAD1400 L

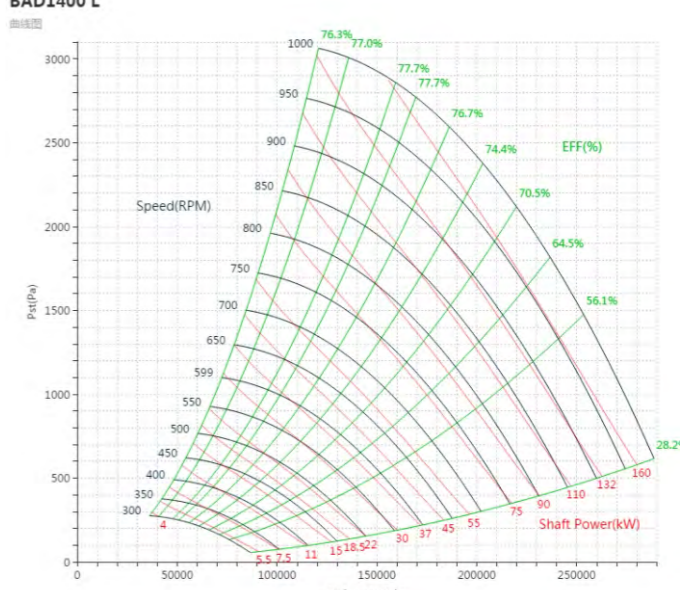

➤ BND曲线图

BND250

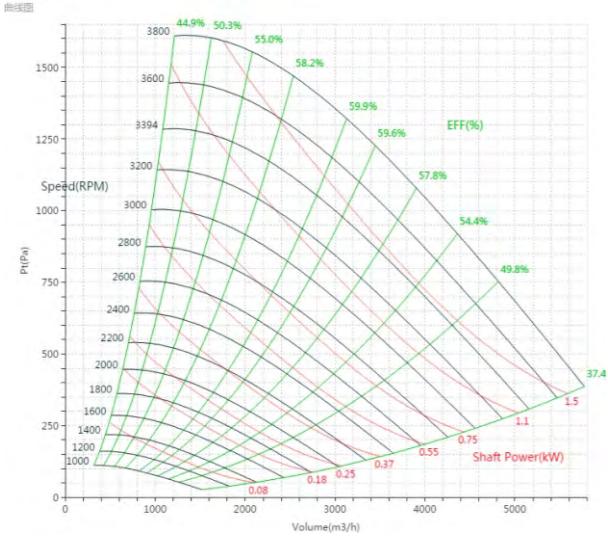

BND280

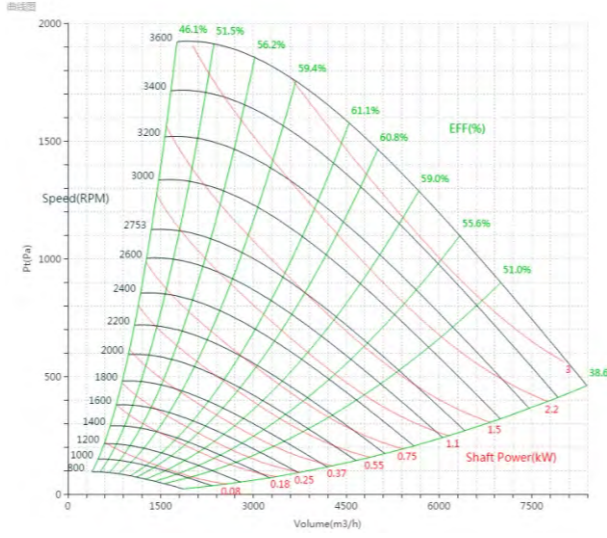

BND400

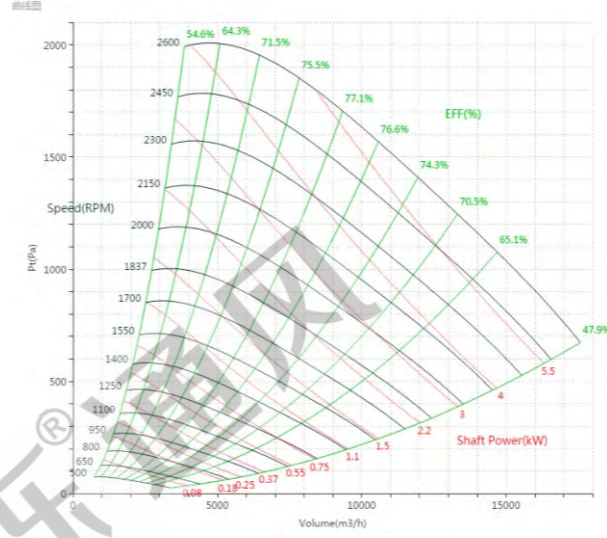

BND450

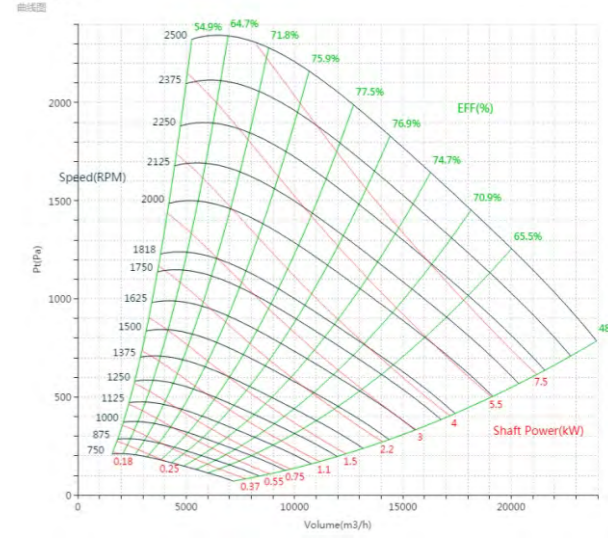

BND315

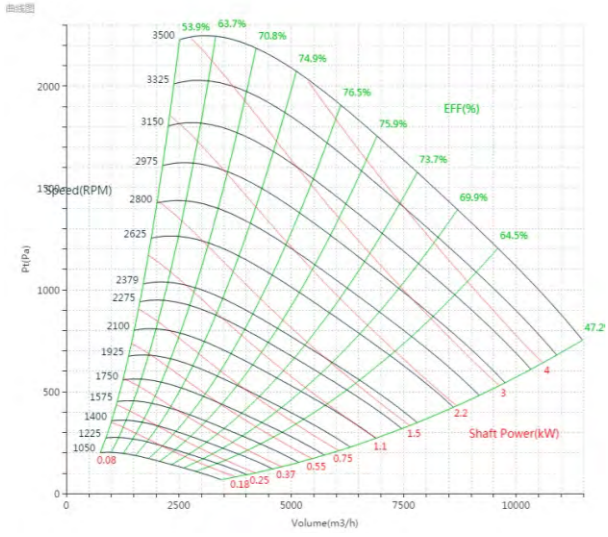

BND355

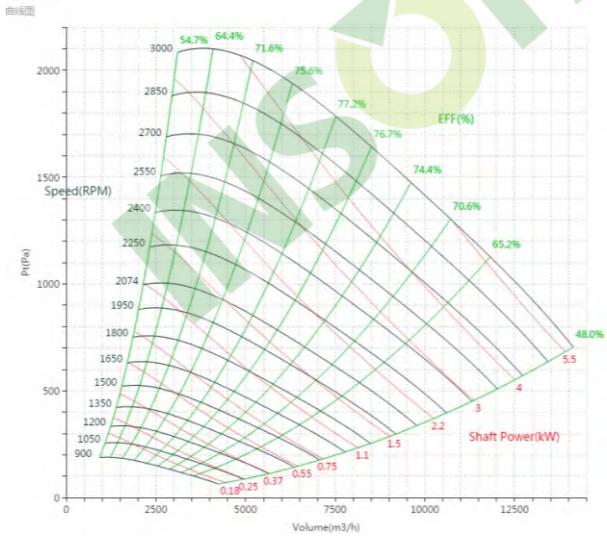

BND500

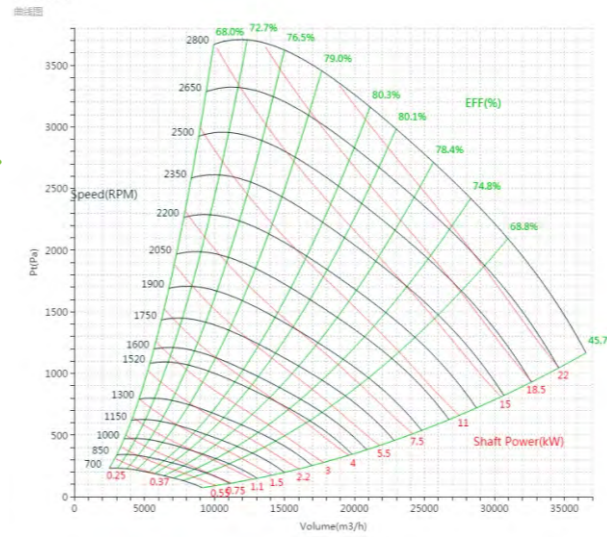

BND560

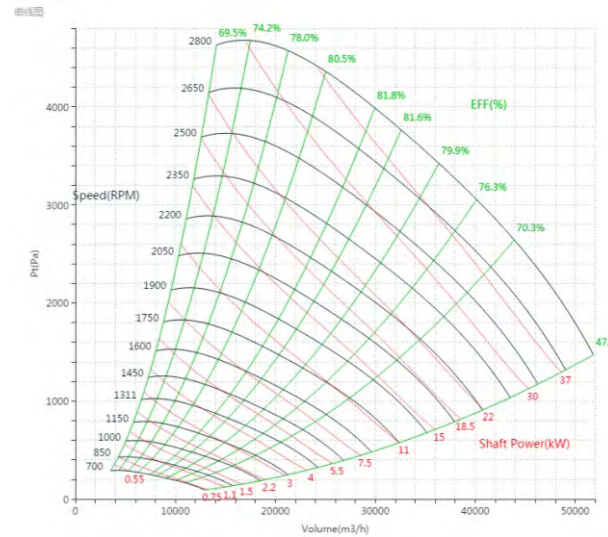

BND/BAD Series

BND/BAD Series

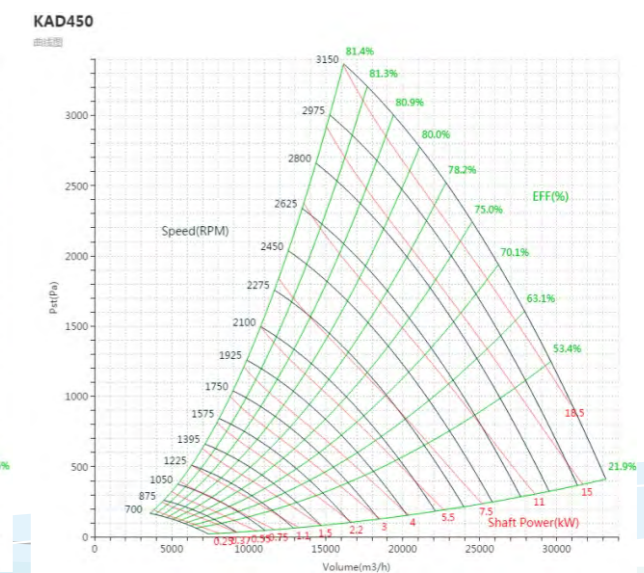
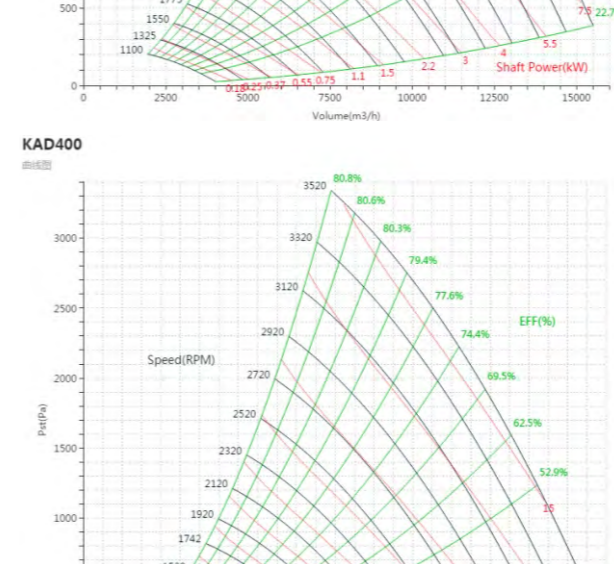
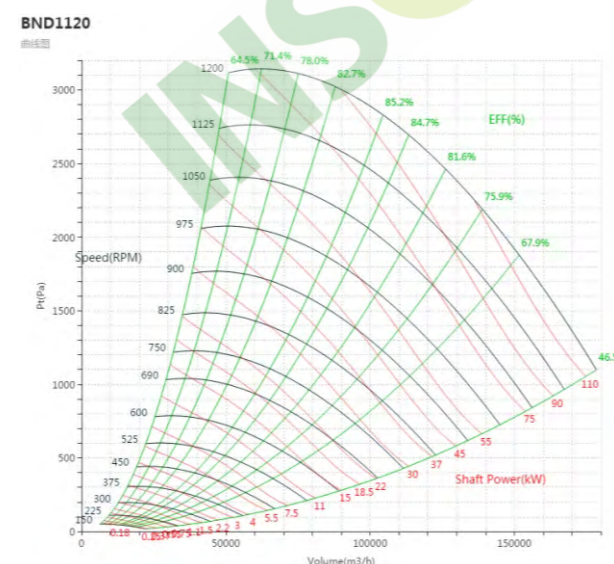
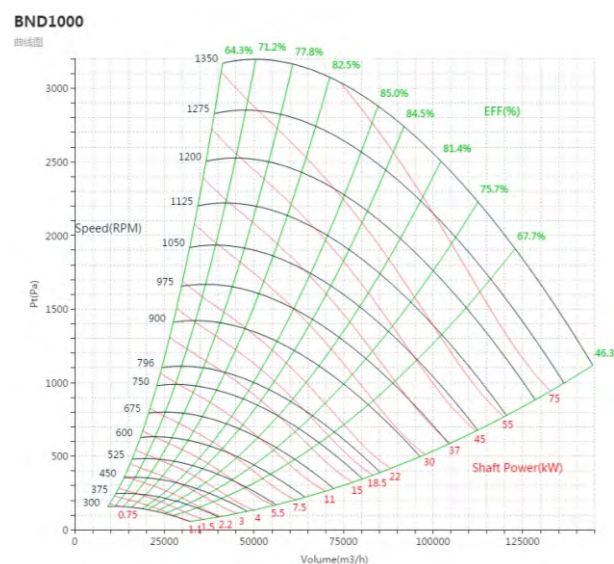
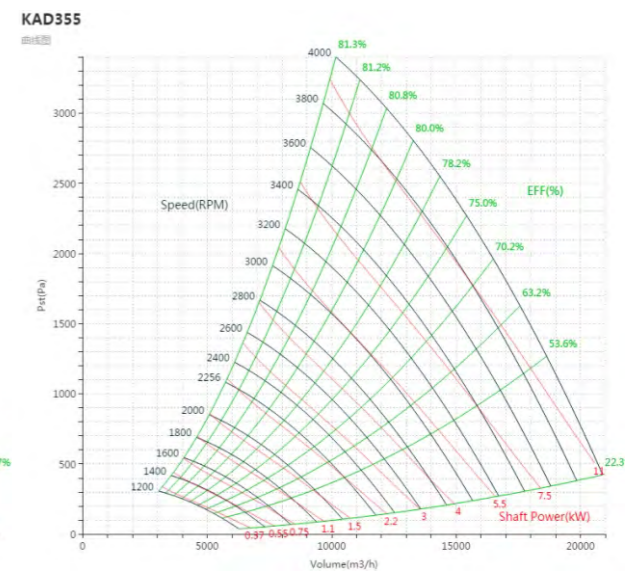
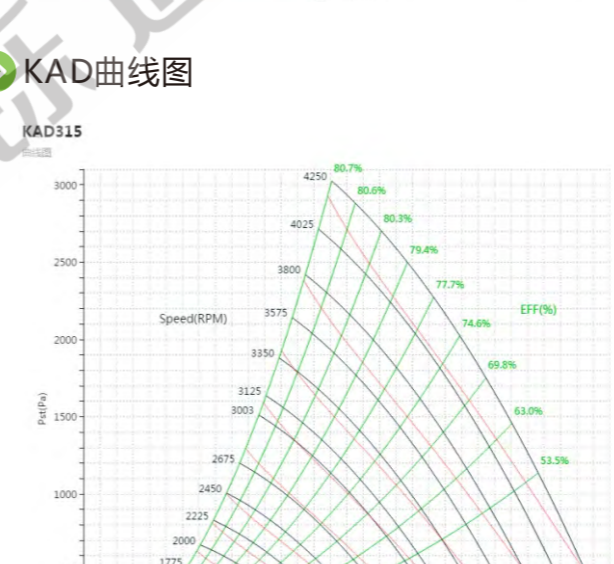
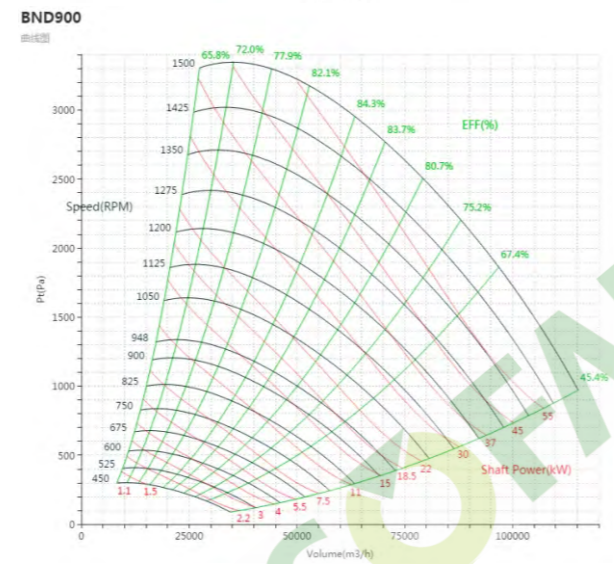
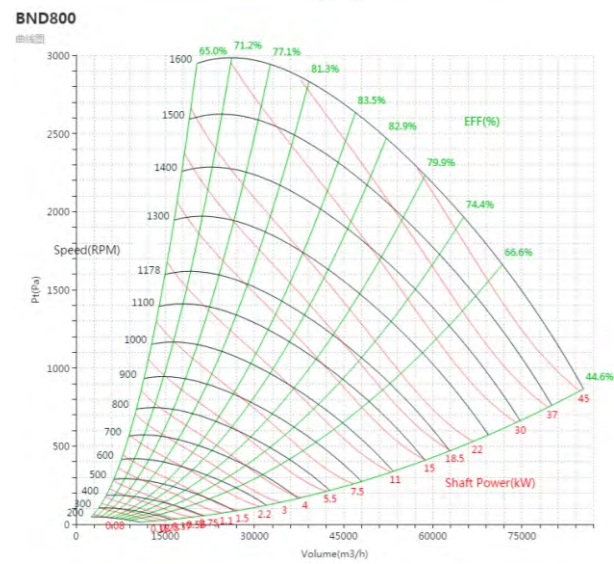
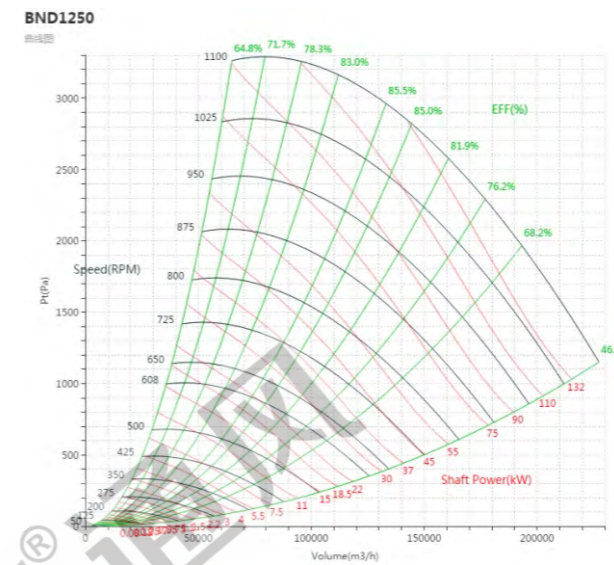
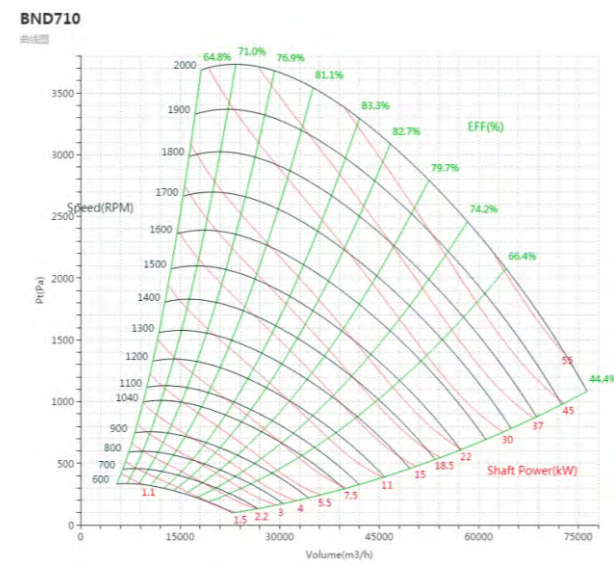
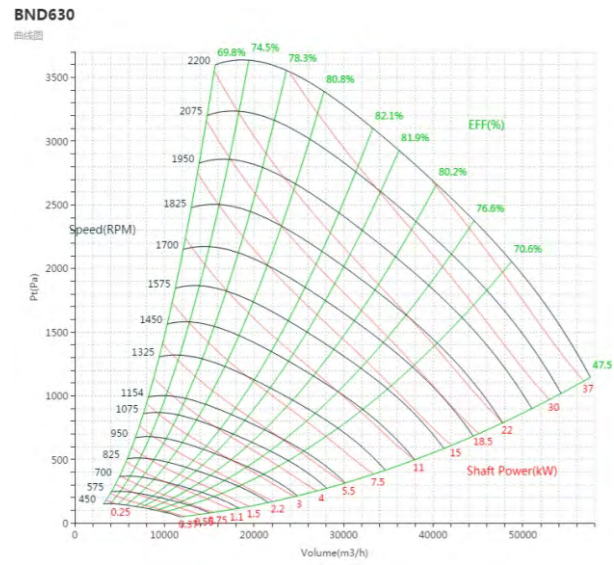

▶ KAD曲线图

BND/BAD Series

BND/BAD Series

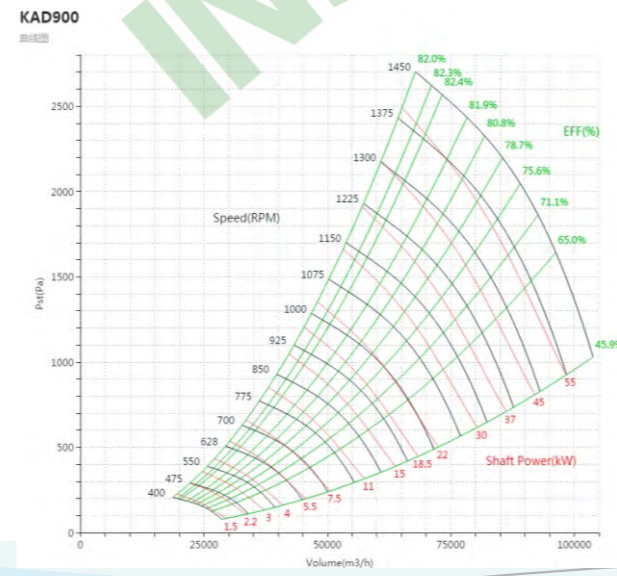
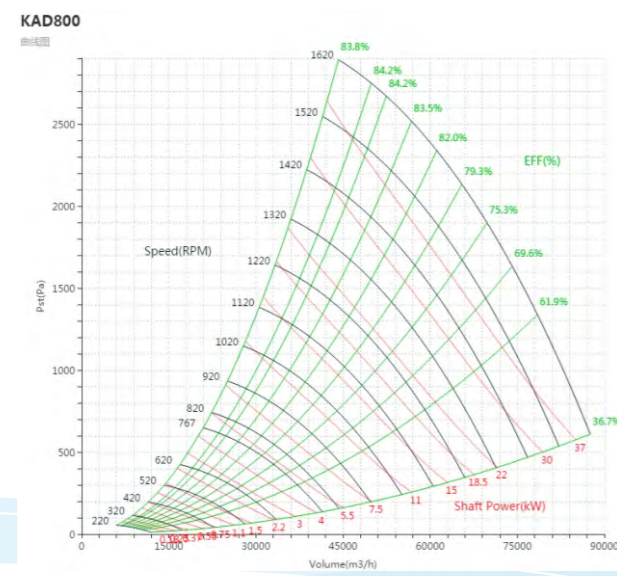
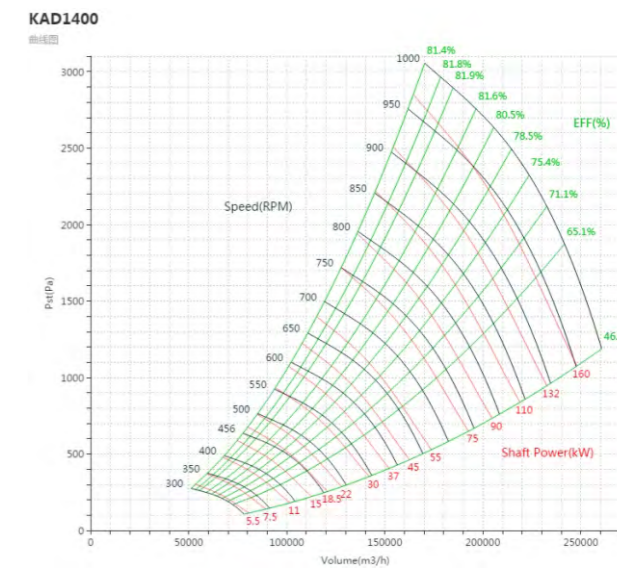
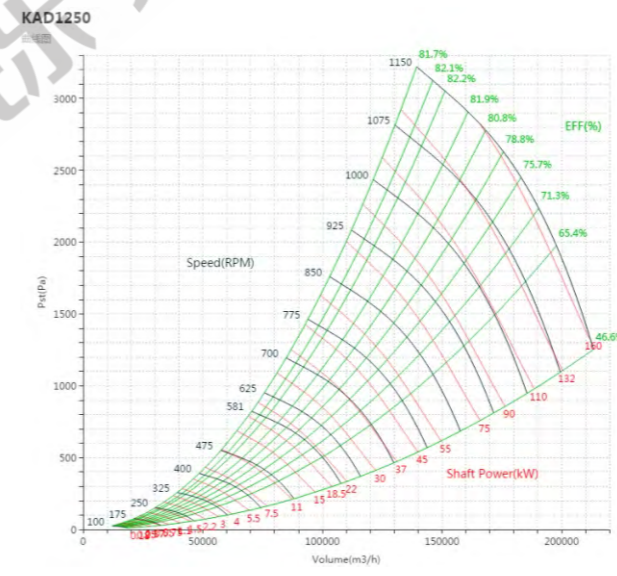
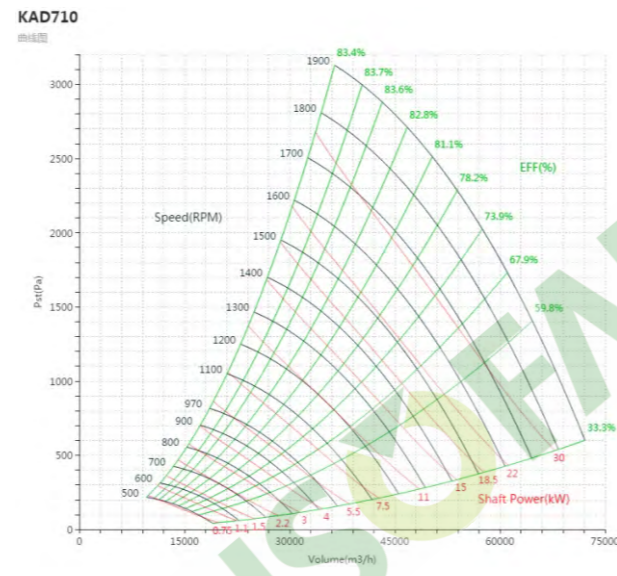
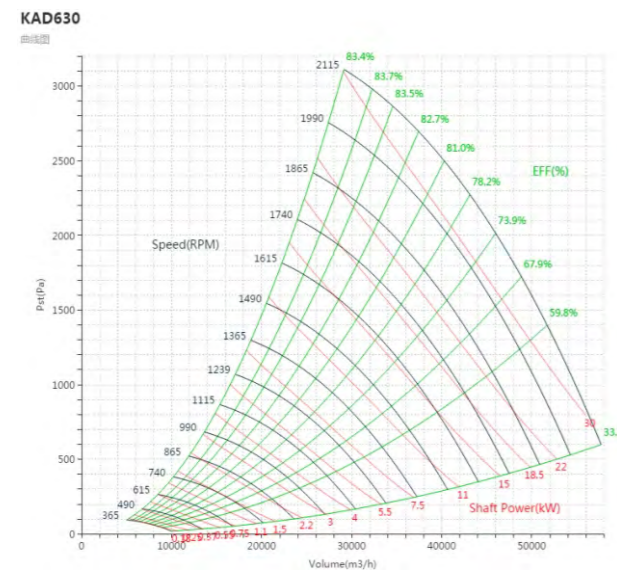
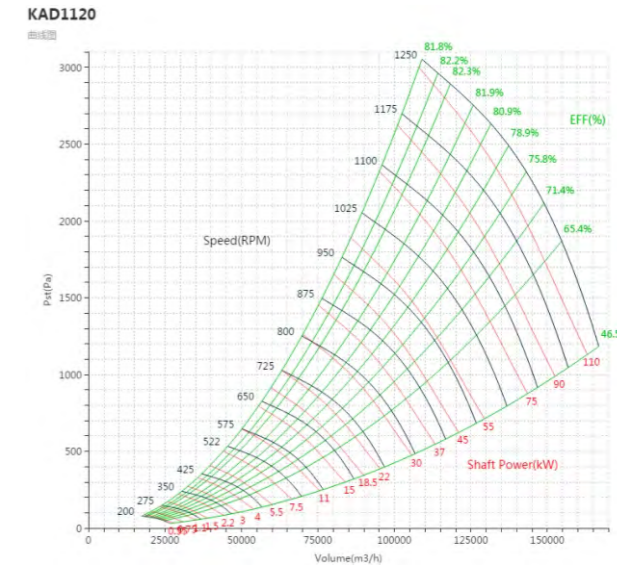
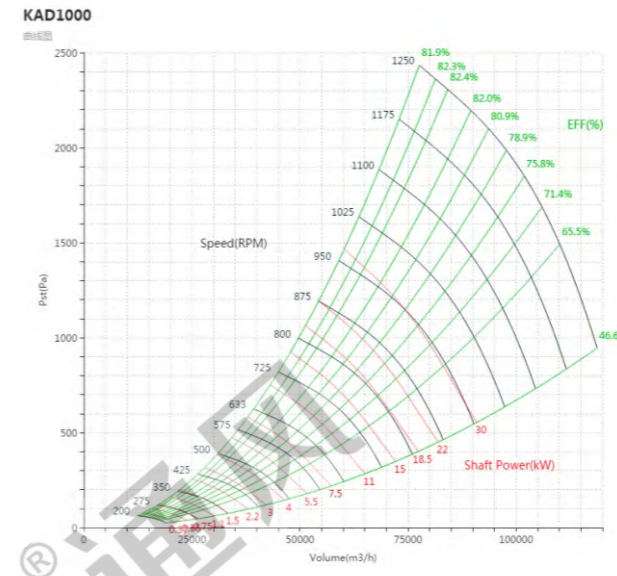
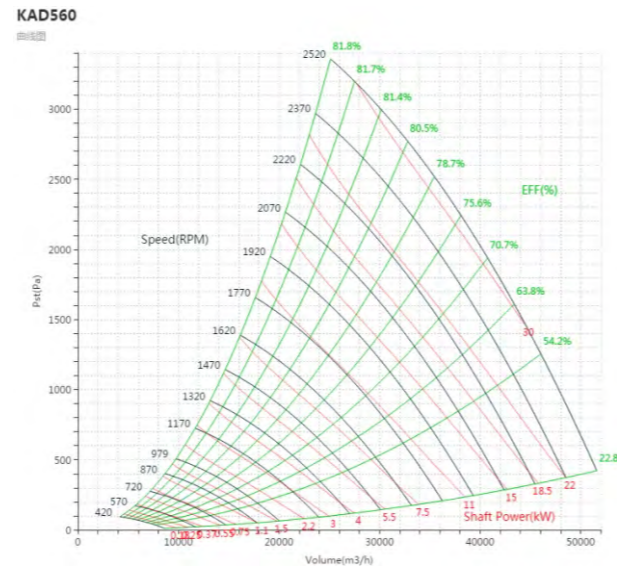
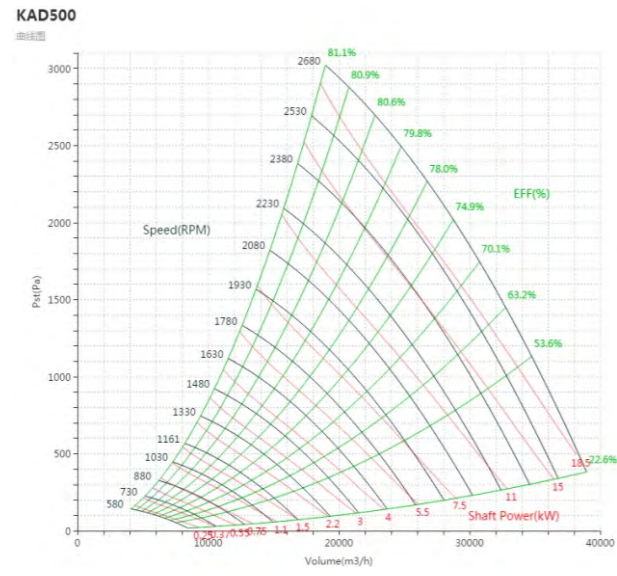

► BND/BAD安装尺寸图
BND/BAD Dimension

BND/BAD-GM Dimension

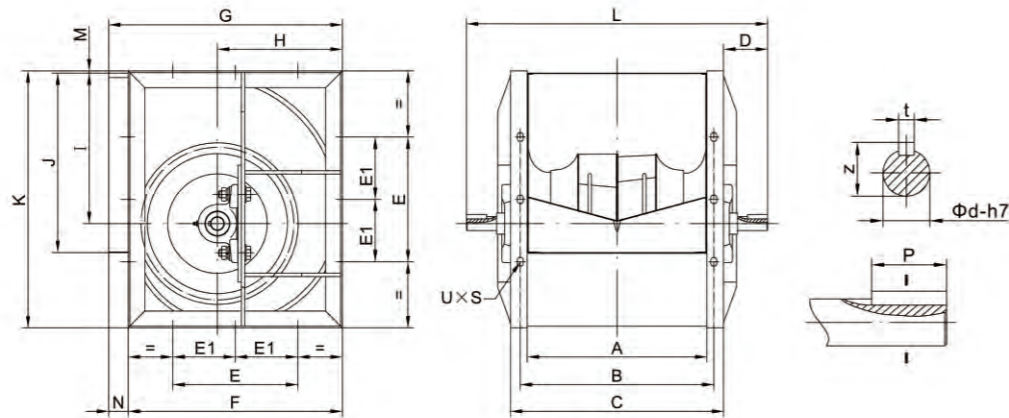

SIZE	A	B	C	D	E	E1	F	G	H	I	J	K	L	M	N	Φd	t	z	P	UXS
500	638	678	718	171	450	250	750	800	448	538	638	918	1060	5	50	40	12	43.3	70	13X18
560	714	764	814	173	450	250	844	892	502	603	714	1030	1160	7	48	50	14	53.8	70	13X18
630	800	850	900	200	450	280	945	998	564	679	800	1157	1300	6	53	50	14	53.8	90	13X18
710	898	948	998	217	450	315	1057	1120	636	765	888	1302	1432	7	63	60	18	64	90	17X22
800	1006	1056	1106	217	450	355	1180	1254	714	862	996	1468	1540	7	74	60	18	64	90	17X22
900	1130	1180	1256	208	450	400	1319	1408	804	971	1120	1648	1672	7	89	60	18	64	100	17X22
1000	1266	1316	1392	213	450	450	1450	1540	884	1066	1256	1810	1818	9	90	60	18	64	100	17X22

说明：所有尺寸允许偏差±4mm
Note: Overall dimension tolerance arange ±4mm .

BAD1120-1400 Dimension

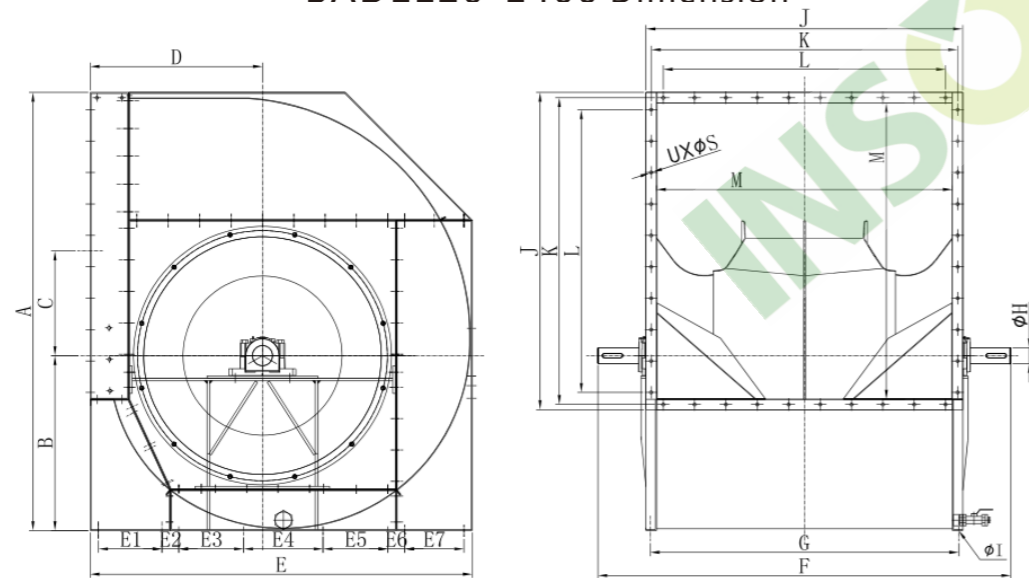

SIZE	A	B	C	D	E	E1	E2	E3	E4	E5	E6	E7	F	G	ΦH	ΦI	J	K	L	M	UxΦS
1120	2092	835	500	824	1827	304	80	310	380	310	80	283	1975	1475	Φ75	Φ16	1515	1465	1350	1415	40xΦ15
1250	2329	931	580	910	2029	323	80	382	380	380	80	324	2125	1646	Φ75	Φ16	1686	1636	1500	1586	44xΦ15
1400	2616	1047	621	1000	2260	350	80	430	430	430	80	380	2517	1846	Φ90	Φ16	1896	1836	1600	1776	48xΦ15

若需要风机底座安装尺寸，请与我司联系。

BND/BAD-D Dimension

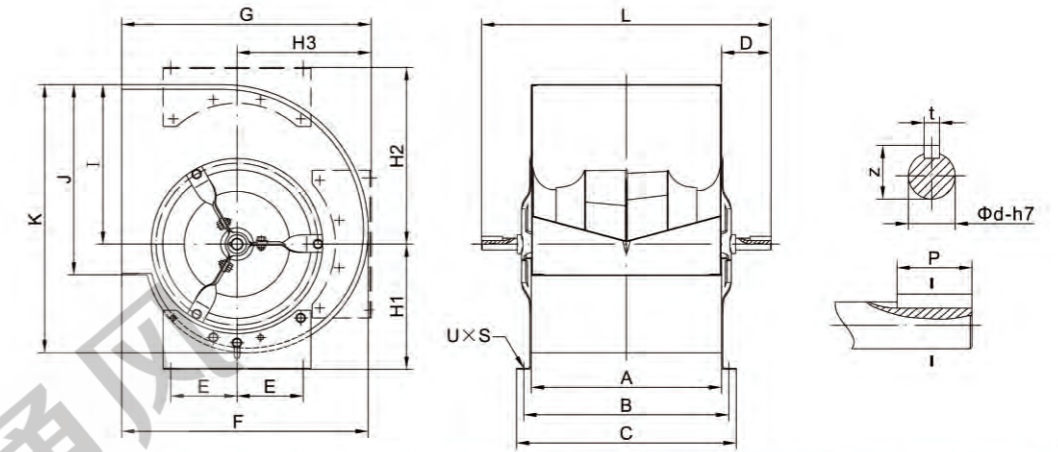

Size	A	B	C	D	E	F	G	H1	H2	H3	I	J	K	L	Φd	t	z	P	UXS
200	256	281	306	82	224	306	348	181	245	184	215	256	364	420	20	6	22.8	40	11X16
225	288	313	338	86	224	348	384	197	274	204	243	288	408	460	20	6	22.8	40	11X16
250	322	347	372	84	224	384	422	212	299	227	270	322	454	490	20	6	22.8	40	11X16
280	361	391	421	90	280	432	470	236	331	255	302	361	510	540	25	8	28.3	40	11X16
315	404	434	464	98	280	480	519	261	370	283	340	404	572	600	25	8	28.3	40	11X16
355	452	492	532	110	315	548	580	274	411	320	383	452	644	672	30	8	33.3	40	11X16
400	506	546	586	93	110	612	649	302	462	359	432	506	724	726	30	8	33.3	40	11X16
450	568	608	648	115	123	681	729	336	518	407	486	568	816	814	35	10	38.3	50	13X18

BND/BAD-K Dimension

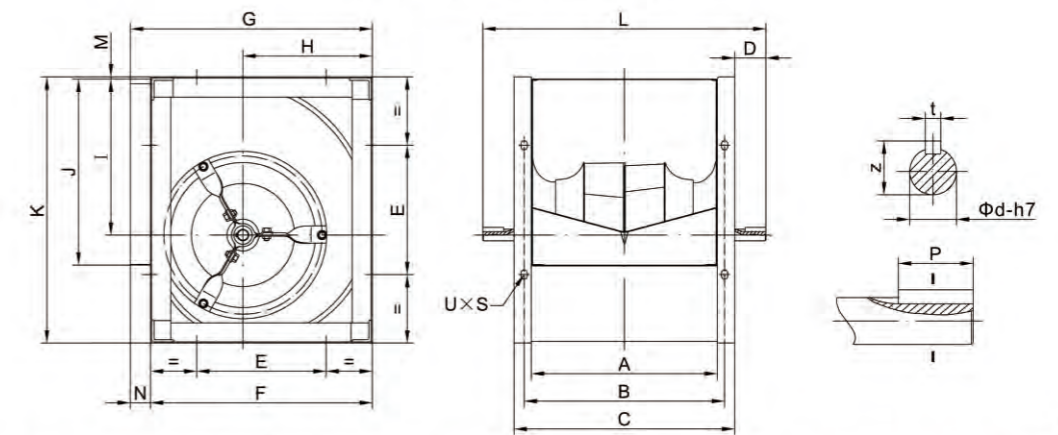

Size	A	B	C	D	E	E1	F	G	H	I	J	K	L	M	N	Φd	t	z	P	UXS
200	256	281	316	52	224	306	343	179	215	256	370	420	4	37	20	6	22.8	40	11X16	
225	288	313	348	56	224	348	383	203	243	288	415	460	3	35	20	6	22.8	40	11X16	
250	322	347	382	54	224	384	419	224	270	322	461	490	4	35	20	6	22.8	40	11X16	
280	361	391	421	60	280	432	466	251	302	361	518	540	5	34	25	8	28.3	40	11X16	
315	404	434	464	68	280	480	518	282	340	404	578	600	3	38	25	8	28.3	40	13X18	
355	452	492	532	70	315	548	578	318	383	452	654	672	6	30	30	8	33.3	40	13X18	
400	506	546	586	70	355	612	650	360	432	506	736	726	5	38	30	8	33.3	40	13X18	
450	568	608	648	83	400	681	726	404	486	568	827	814	5	45	35	10	38.3	50	13X18	

说明：所有尺寸允许偏差±4mm
Note: Overall dimension tolerance arange ±4mm .

BND/BAD-HL Dimension

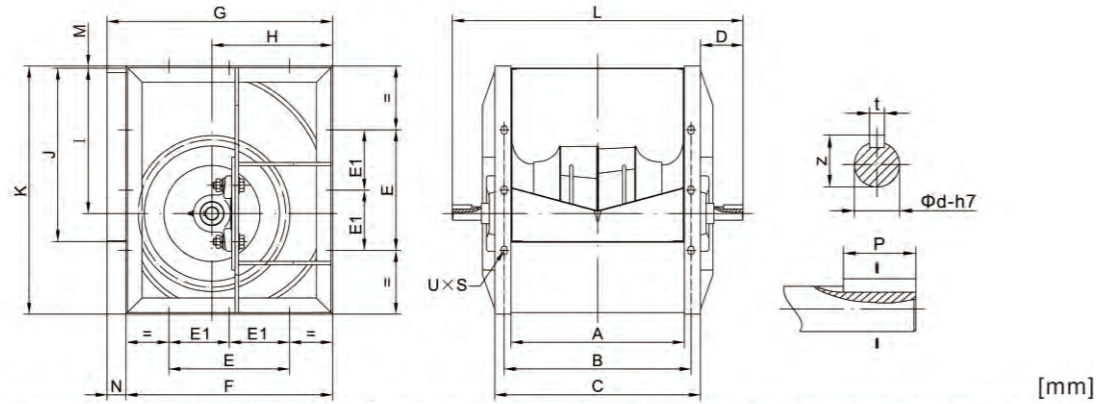

SIZE	A	B	C	D	E	E1	F	G	H	I	J	K	L	M	N	Φd	t	z	P	UXS
200	256	281	316	77	224	306	343	179	215	256	370	470	4	37	20	6	22.8	40	11X16	
225	288	313	348	81	224	348	383	203	243	288	415	510	3	35	25	8	28.3	40	11X16	
250	322	347	382	79	224	384	419	224	270	322	461	540	4	35	25	8	28.3	40	11X16	
280	361	391	421	77	280	432	466	251	302	361	518	575	5	34	25	8	28.3	40	11X16	
315	404	434	464	84	280	480	518	282	340	404	578	632	3	38	25	8	28.3	40	13X18	
355	452	492	532	84	315	548	578	318	383	452	654	700	6	30	30	8	33.3	40	13X18	
400	506	546	586	87	355	612	650	360	432	506	736	760	5	38	30	8	33.3	40	13X18	
450	568	608	648	98.5	400	681	726	404	486	568	827	845	5	45	35	10	38.3	50	13X18	
500	638	678	718	98.5	450	750	800	448	538	638	918	915	5	50	35	10	38.3	50	13X18	
560	714	764	814	93	560	844	892	502	603	714	1030	1000	7	48	40	12	43.3	70	13X18	
630	800	850	900	95	630	945	998	564	679	800	1157	1090	6	53	45	14	48.5	70	13X18	
710	898	948	998	128.5	710	1057	1120	636	765	898	1302	1255	7	63	50	14	53.5	90	17X22	
800	1006	1056	1106	141	800	1180	1254	714	862	1006	1468	1388	7	74	55	16	59	90	17X22	
900	1130	1180	1256	155	900	1319	1408	804	971	1130	1648	1566	7	89	60	18	64	90	17X22	

BND/BAD-HM Dimension

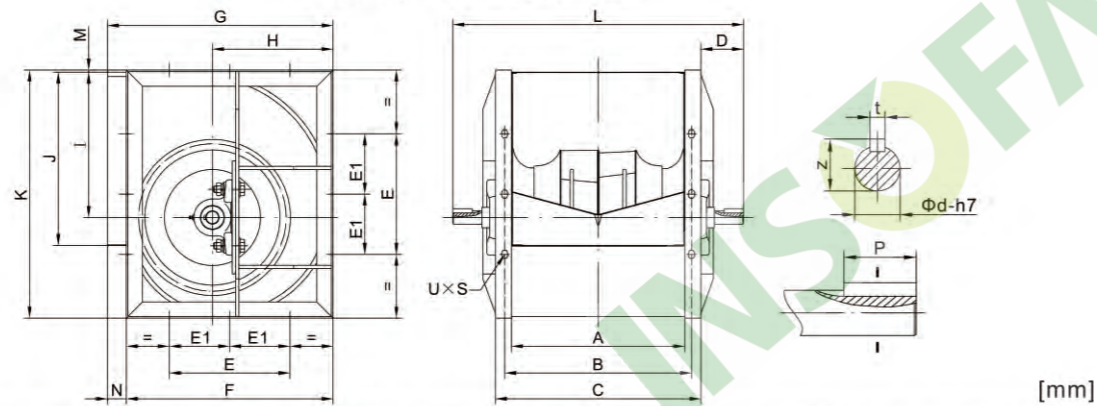

SIZE	A	B	C	D	E	E1	F	G	H	I	J	K	L	M	N	Φd	t	z	P	UXS
200	256	281	316	77	224	306	343	179	215	256	370	470	4	37	20	6	22.8	40	11X16	
225	288	313	348	81	224	348	383	203	243	288	415	510	3	35	25	8	28.3	40	11X16	
250	322	347	382	79	224	384	419	224	270	322	461	540	4	35	25	8	28.3	40	11X16	
280	361	391	421	77	280	432	466	251	302	361	518	575	5	34	25	8	28.3	40	11X16	
315	404	434	464	84	280	480	518	282	340	404	578	632	3	38	30	8	33.3	50	13X18	
355	452	492	532	93	315	548	578	318	383	452	654	718	6	30	35	10	38.3	50	13X18	
400	506	546	586	93	355	612	650	360	432	506	736	772	5	38	35	10	38.3	50	13X18	
450	568	608	648	115	400	681	726	404	486	568	827	878	5	45	40	12	43.3	70	13X18	
500	638	678	718	119	450	750	800	448	538	638	918	956	5	50	40	12	43.3	70	13X18	
560	714	764	814	128	560	844	892	502	603	714	1030	1070	7	48	45	14	48.3	70	13X18	
630	800	850	900	127.5	630	945	998	564	679	800	1157	1155	6	53	50	14	53.8	90	13X18	
710	898	948	998	141	710	1057	1120	636	765	898	1302	1280	7	63	55	16	59	90	17X22	
800	1006	1056	1106	141	800	1180	1254	714	862	1006	1468	1388	7	74	55	16	59	90	17X22	
900	1130	1180	1256	155	900	1319	1408	804	971	1130	1648	1566	7	89	60	18	64	100	17X22	
1000	1266	1316	1392	213	1000	1450	1540	884	1066	1266	1810	1818	9	90	65	18	69	100	17X22	

说明：所有尺寸允许偏差±4mm
Note: Overall dimension tolerance range ±4mm.